

SHERLINE

Hydraulic Trailer Tongue Weight Scale

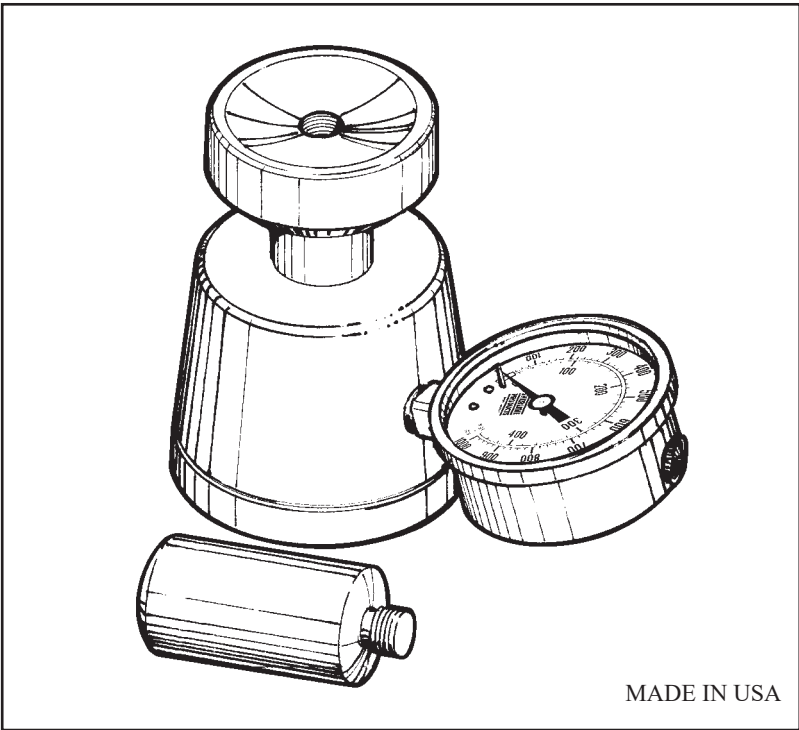

Instructions for Use, and Trailer Loading, and Towing Guide

NOTE: The Sherline scale is not intended to be used for trade; that is, items priced by weight.

Precautions

- **Do not pick up the scale by the piston.** Air can be drawn past the O-ring seal and into the cylinder, causing incorrect readings.
- **Do not shock load the scale.** Suddenly dropping a weight onto or off of it can cause the gauge needle to spin and lose its position so that it no longer reads in the zero range when there is no load on it. If this occurs the gauge must be replaced.
- **Readings should be taken with the scale in a level position.** Friction on the piston from side loads can cause an incomplete reading.
- If the scale has not been used in a long time, **rotate the piston in the cylinder** slightly to free up the O-ring seal before using. (Do not pull on piston.)
- **Do not leave weight resting on the scale** for longer than is necessary to take a reading.
- **Do not “peg” the scale.** As weight is lowered onto it, make sure the scale does not exceed its maximum weight reading or the gauge can be damaged.
- **See page 11** for how to replace lost fluid or install a new gauge.
- **See pages 13 and 14** for more detailed descriptions on care and use of the trailer tongue weight scale.

NOTE: Replacement gauges are available in 0-1000 lb, 0-2000 lb and 0-5000 lb ranges.

Table of Contents

Trailer Loading and Towing Guide

Why the Sherline™ Scale Came into Being.....	1
Introduction.....	1
The Tow Vehicle	2
Vehicle and Trailer Brakes.....	3
The Hitch	3
The Trailer Ball and Safety Chains.....	4
Trailer Lighting and Connections	4
Tires and Wheel Bearings	5
Recommended Hitch Weight Percentages	6
Placing the Load	6
Determining Maximum Gross Trailer Weight	7
Weighing the Trailer.....	8
Your Responsibilities as a Driver.....	9
Driving in Windy Conditions.....	9
Wind and Passing Trucks.....	10

Instructions for Use of the Sherline Trailer Scales

How the Sherline Tongue Weight Scale Works	10
Recommended Gauge Ranges	10
Changing Gauges.....	11
Placement of Your Sherline Scale.....	11
Parts Diagram and Description	13
Care and Use of Your Sherline Trailer Weight Scales	14
Key Points to Keep in Mind when Using Your Scale.....	15
In Conclusion	16
Acknowledgments.....	16
Safe Towing Checklist	16
Trailer/Tow Vehicle Load Worksheet.....	17
Warranty.....	18

Disclaimer

Sherline Products Inc. is not responsible for any damage or injury caused by use or misuse of the Sherline™ Scale. The examples given in this booklet are general guidelines for illustration purposes only and cannot cover every possible combination of vehicle, hitch, and trailer, or every loading situation. Have your particular rig inspected by an authorized trailer or hitch installation/repair facility before towing heavy loads or if any handling problems occur. There are handling problems that cannot always be solved by proper trailer loading. You are solely responsible for the safe loading and operation of your vehicle and trailer.

The Sherline scale is not intended for trade purposes; i.e. items sold by weight.

Trailer Loading and Towing Guide

*Don't learn the
hard way.*

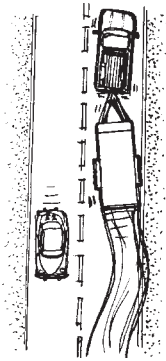

Handling trailer sway...

If swaying occurs, steer as little as possible while you slow down. Because of your natural lag in reaction time, quick steering movements will actually make things worse and cause the oscillation to increase. Application of the trailer brake usually tends to help keep the vehicles aligned, while heavy braking with the tow vehicle may reduce trailer stability. Until the problem is identified and solved, travel at reduced speeds.

*If a trailer is
properly loaded and
still handles poorly,
it's time to seek
professional help.*

Why the Sherline™ Scale Came into Being

Joe Martin came up with the idea to manufacture this product after improperly loading his own trailer and almost losing his rig, which was carrying his pride and joy back from a race. He owned a 1974 Indy Car that he raced in vintage events. Being very mechanically inclined and owning a large machine shop that produces tools, he was embarrassed to realize what had happened and thought how much easier it would be for a person with less experience to make this mistake. He shuddered to think about the accident that could have occurred that night, and hoped that producing this product will not only make a profit but also prevent someone else from making the same error. They may not be as lucky as he was.

Introduction

When we first decided to put together a comprehensive manual on loading trailers we thought it would be easy. We now believe the number of variables that lead to safely towing a trailer can't be written into a few simple rules and have made many companies shy away from the subject. We decided to expand these instructions to be more helpful to our customers that appreciate the need to accurately load a trailer so that it can be safely towed at reasonable speeds. If you know of information that you believe could be useful, we would be happy to add it to future copies of these instructions or refer our customers to it.

We will try to introduce you to problems you may encounter and pass on some basic rules that we have acquired in my research. It is up to you to decide what will work and add the common sense it takes to safely tow a trailer. If a trailer doesn't tow properly when all the basic rules have been followed, the answer can be very complex, because the result can be an oscillating trailer. This is usually caused by a trailer that is "tail heavy," and adding more tongue weight will cure the problem. If it doesn't, you need expert help. The moment a rig shows any tendency in this direction you should slow down and get some expert help on it. Oscillations are very complex because they can be the result of several components working in unison. Speed and wind are two of these components, so you should never drive faster to try and eliminate the oscillation or any other problem. You should start off by towing the trailer without any load. If a problem such as this exists, go to your hitch shop or the dealer that sold the trailer. The information we have covered here cannot solve problems such as these if the basic rules have been followed and oscillation still occurs. It can be very dangerous to experiment with an ill handling rig, especially on a public road.

The Tow Vehicle

If you haven't already purchased a tow vehicle you can tailor its specifications to your towing needs. Most likely, however, you already have the vehicle you will be using to tow and have based your trailer purchase on its capabilities. It might be wise to ask yourself at this point if the tow vehicle is really big enough to have the brakes and suspension it takes to safely tow your trailer. There isn't any good way to overcome a problem such as this short of trading up to a vehicle with more capacity. If the suspension isn't heavy enough, the brakes probably leave something to be desired. You can get this type of information from manufactures of trailers, trucks, and automobiles but they tend to be optimistic, quoting maximum capacities rather than recommended capacities. Remember also that a half-ton pickup may be able to carry 1000 pounds of weight in the bed, but probably cannot support 1000 pounds at the hitch without special modifications to the suspension. So if you hook up your twenty-four foot cargo trailer to your nice, new half-ton pickup and the headlights are aimed at birds roosting in the trees, there should be a clear message that something is wrong.



You can't always correct the problem by moving the load if the tow vehicle isn't capable of handling the required hitch weight. Moving the load back in the trailer could make for a very unstable and dangerous condition, and leaving too much weight on the hitch can also cause a dangerous situation where the tow vehicle doesn't have enough weight on the front wheels to control your rig. When you hit the brakes, the trailer dives lifting the front end even more, and you lose most of your braking and steering at the same time. Several types of weight redistribution hitches are available that can dramatically help your handling by spreading the forces to both axles, but they can not compensate for inadequate towing capacity or overloading.

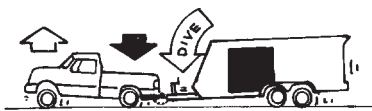

Trailer "Dive" during heavy braking increases effects of tongue weight.

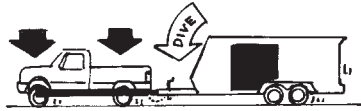

Weight distributing hitch transfers loads to frame and to both axles of tow vehicle for safer stops and smoother ride.

Build a safety margin into your towing by making sure your tow vehicle has more than enough power, suspension and brakes to handle the job you'll be asking it to do.

A Note About Load Equalizing Hitches...

A load equalizing hitch is selected base on the trailer's actual tongue weight rather than on gross weight. This type of hitch has some real advantages, but government studies have shown they can actually work too well, lightening the load on the rear wheels of the tow vehicle sufficient to reduce traction. This kind of hitch should be selected carefully, installed by professionals and its operation understood by the user.

Towing Tip...

Vehicle Wheel Paths

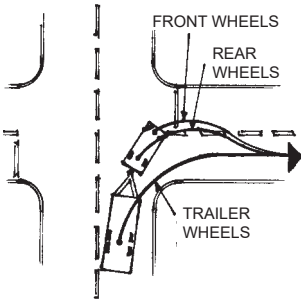

The longer the trailer, the wider you must swing in a turn to make sure the trailer wheels clear the inside curb.

Brakes should have plenty of capacity and be in perfect condition for trailer towing. "You can't have too much brake."

Talk to a qualified hitch installation shop about your particular needs. Also contact the manufacture of your trailer to see what they recommend. This leads to the first and most basic rule of trailer towing:

The tow vehicle and hitch must be capable of safely handling at least 15% of the gross weight of the trailer (total weight of trailer plus contents). Fifth wheel trailers usually have up to 25% of the gross weight on the hitch.

Vehicle and Trailer Brakes

Although it is beyond the scope of these instructions to cover everything, we believe we should mention brakes. If you can't get to the top of a hill from lack of power you can usually pull over and it may cause an inconvenience but not a disaster. If the brakes fail going down a hill you have a problem that can cause a disaster. You can't have too much brake. Disk brakes are better than drum brakes. Four electric brakes on your trailer are better than two. New pads are better than old pads. We think you get the idea. You should be able to stop your rig on a hill without the trailer brakes. If you can't, you'd better pay a lot more attention to that corroded connector you have been hooking up your trailer with.

When learning, get on a lonely road without any traffic and try practicing panic stops. Of course, you shouldn't just slam on your brakes. You should try to slowly shorten your stopping distance by applying more pressure. Don't take it to the point that you lose control, just enough to get a feeling what it takes to make a quick stop and the distances involved. My guess is that you will find yourself leaving more room in front of you once you make this test. Don't ride the brakes going down hills as this overheats brakes, causing them to lose effectiveness. Use the engine and lower gears to control the downhill speed on long hills. Learn how electric brakes work and how to adjust the modern day controllers that actuate them. Remember that the slightest pressure to the brake pedal will apply the electric brakes. Keep your foot off the brake pedal unless you intend to use them. They shouldn't be allowed to be on for extended periods. The basic drag of these brakes are set with the control, not how hard you press the pedal. A pendulum type control will electronically add more brake as you stop, but if you have your controller turned all the way up, the slightest pressure on the pedal could lock your trailer brakes.

The Hitch

Before towing anything, have your hitch inspected by a qualified hitch installation company, and have them determine what the maximum tongue weight can be. This is usually 10% of the hitch's rated capacity. Note, the term is *hitch*, not *ball*. A *ball* is rated by its towing capacity. A *hitch* is rated by not only its towing capacity but also by the tongue weight. Again,

the safest way to accomplish this is to take your vehicle to a shop that specializes in installing hitches. If they don't have a welder go to another shop. Hitch problems are usually fixed by welding, not with a couple of nuts and bolts. If you have a bumper type hitch, don't tow anything your wife can't lift onto the ball. The biggest error you can make is "cheaping out" and not going to a qualified shop.

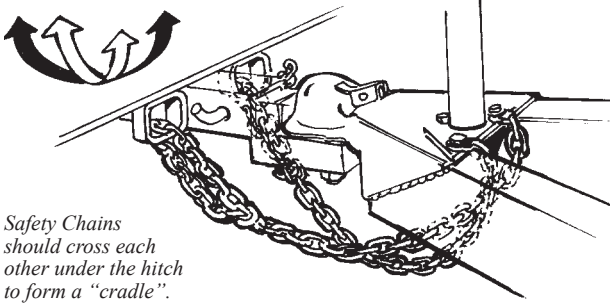

Safety Chains should cross each other under the hitch to form a "cradle".

The Trailer Ball and Safety Chains

The ball should be located so the trailer sits level when connected to the tow vehicle. The vehicle should be able to accept this weight without a major change of attitude. The ball should be lightly greased so the hitch rotates smoothly on it. Safety chains should be long enough for tight turns and be crossed (right to left and left to right). This will help create a "saddle" if you have a tongue failure and will help maintain control while stopping. Don't allow these chains to drag on the pavement, because they can be ground to an unsafe condition in a very short amount of time.

Always inspect the hitch and tongue for cracks when hooking up. Rust is your enemy and can cause premature failures. Check lights and brakes each time the trailer is hooked up. Try to do things in the same order each time and use a checklist. Don't forget to retract the jack. Don't ever hook a trailer up half way or you may forget to finish the job. Don't start if you can't finish, and don't ever leave the receptor pin out for a minute.

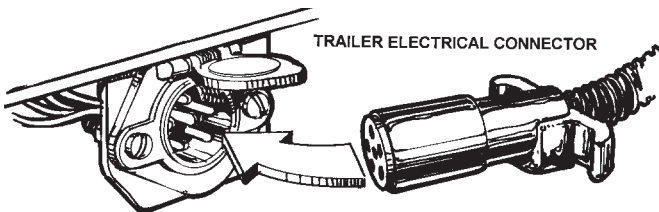

Trailer Lighting and Connections

Lights must work to be safe. The weakest link is the connector. They corrode easily and need constant attention to keep the

Be sure the hitch is capable of handling the required tongue weight. Have it checked by a pro.

Hooking up the trailer should be a carefully observed ritual that can't allow errors.

Maintain your electrical system. It is usually a weak spot that requires constant attention

Torquing order for various wheel lug nut patterns as suggested by a large trailer manufacturer. A straight-across "star" pattern is also often used for 5 and 10-bolt patterns.

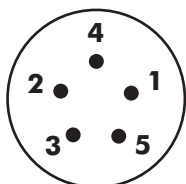

5-BOLT

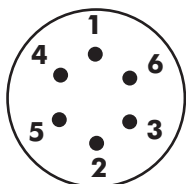

6-BOLT

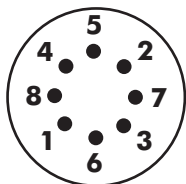

8-BOLT

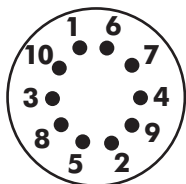

10-BOLT

system working. (Be careful when cleaning connectors not to short them out.) If we had more time we would manufacture a good one, because I'm sure there is a market for one. The wiring to the connector should be carefully routed so that it can't come apart in tight turns or chafe through and short out. Remember, electric brakes also run through this connector. Have an observer confirm your brake lights, blinkers and running lights are working properly each time you hook up.

Tires and Wheel Bearings

Tires...

Tires have to be checked frequently with a trailer because a flat can go unnoticed on multiple axle trailers while it is being towed. Running with a flat can cause it to catch fire and burn up your rig. With multiple axles or tandem wheels it is hard sometimes to see a flat tire as the other tires are supporting the weight of the rig and the flat spot is less noticeable. A quick check can be made by "thumping" each tire with a tire iron or rod to make sure they all sound the same. Each time you gas up, walk around the trailer and give a quick check by feeling each tire with your hand. A tire that is getting low will be hotter than the rest. There is no substitute, however, for actually measuring tire pressures to make sure they are all within safe limits. This should definitely be done before each trip.

NOTE: The most common causes of tire failure are overloading and under inflation. Both result in excess flexing of the sidewall which causes heat buildup and eventual failure. Continuing to run with a flat can cause it to catch fire.

Wheels and Lug Nuts...

Trailers have higher wheel loading than passenger cars or trucks. Tandem axles do not steer, and wheels are subjected to high twisting side loads in tight, slow turns. This causes the wheel to flex which tends to loosen wheel lug nuts over time. Always check lug nut torque before each trip. A suitable torque wrench only costs about \$30 and is a worthwhile investment considering the value of your trailer.

Wheel lug nut torque is usually much higher than that specified for passenger car wheels. Check your particular trailer's recommended specifications. Most are in the 90-95 ft.-lb. range. On a new trailer, check the torque on all wheels after the first 25-50 miles of towing. Also recheck any wheel that has been removed and replaced after towing 25 to 50 miles. Do not drive a loaded trailer with a missing lug nut or damaged lug bolt.

Wheel lug nuts are torqued in a "star" pattern, crossing over to opposite sides as you work around the wheel. Shown to the left are the usual orders for tightening nuts on various bolt patterns as suggested in a trailer owner's manual.

Wheel Bearings...

Axle wheel bearings also occasionally need attention. Feel with your hand at the hub to check for one that may be running hotter than the rest. (Be careful. If the bearing is adjusted too tight or is running without grease it can get VERY hot!) A hot bearing needs immediate attention. Most often either more grease or proper adjustment will ease the problem, but replacement may be necessary. Boat trailers are a particular source of wheel bearing problems as they are often put in and out of the water. A warm bearing that is suddenly cooled by being immersed in water tends to suck water into the inside as the air cools and shrinks. The water causes the bearings to rust and fail. Spring-loaded pressurized bearing caps are recommended to eliminate this problem. They are cheap and work great.

A trailer isn't any safer than the tires it runs on, and the tires aren't safe if they are old and weather checked (cracked), worn out or improperly inflated.

Recommended Hitch Weight Percentages

Type of Trailer	Percent of Wt. on the Tongue
Single Axle	10% minimum/15% maximum
Tandem Axle	9% to 15%
Travel Trailer	11% to 12%
5th Wheel	15% to 25%

Placing the Load

It would be overly simplistic to say, "Put the heavy items over the axles." Sometimes a lot of little items can far outweigh one big one. We believe the value of an item should be one of the first considerations of where it is put in a trailer. Arrange the load so that these items are protected by their location. Don't put big, heavy items in a place where they can't be securely tied down. A glued down rug makes a great floor for a cargo trailer. Things stay put and don't slide around. Of course, it would be easy to say everything should be securely tied down, but it would be also unrealistic. Start with top heavy items if you have them. That's usually a good place to start because you must have plenty of room available to properly tie them down. Tying them straight down is not secure enough. They need to be tied off at several angles or they could fall over in an abrupt change in speed or direction. You need room to accomplish this. Smaller items can be used to fill the spaces around them later.

Once you have the heavy items located, check the tongue weight with your Sherline™ scale. If the load is radically off, make the changes necessary to get close. The smaller items can be loaded in such a way that they balance out the load. They should be located so that they will stay put. Placing

A note about winch type tie-downs...

There are many kinds of tie-downs available to help anchor a load. The kind with a built in winch are especially good as they allow you to adjust the tension on the lines accurately. Don't trust cheap ones. The kind with a light weight bent metal hook may list a high load capacity but can straighten out and not hold if a sudden shock load is placed on them during an emergency maneuver. Spend a little more and buy way more capacity than you think you need. It's good insurance. If you use rope, the same thing goes...use good, sturdy rope, not clothesline or old, knotted rope.

Towing Tip...

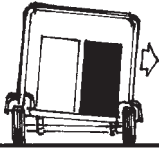

Heavy items loaded to one side of the trailer can cause oscillation or handling problems in turns.

them next to items that have already been tied down helps, but your main concern should be to not lose the balance of the trailer. Don't forget you can also get one side of a trailer a lot heavier than the other without a little planning. This can cause a very serious problem when cornering, even causing the trailer to turn over in a sudden turn.

Top heavy loads can cause problems not only in cornering but also in hard braking. They have a tendency to make the trailer "dive" in hard braking conditions. This suddenly increases tongue weight and can decrease front axle loading just when you need steering and those big front disc brakes the most. Center top heavy items or arrange the remainder of the load to act as a counter weight to minimize this effect.



Top heavy loads can cause trailer "dive" under hard braking, possibly reducing control.

Consider weight, size, center of gravity, location of tie downs, and value when locating cargo in the trailer to end up with the proper tongue weight.

Never place heavy objects on add-on devices hung on the rear bumper or placed across the tongue frame. A bicycle may be fine to hang out in back, but not a motorcycle. This places heavy objects where they will dramatically effect handling in corners or bumps. Heavy weights placed well behind the axle can also aggravate swaying in turns.

It is not possible in this booklet to cover every conceivable loading or trailering situation. The best advice we can give is to use good common sense and to always allow plenty of margin for safety. The purpose behind the Sherline™ scale and this booklet is to try to give you the necessary information to make intelligent, informed decisions when loading. The ultimate responsibility for using that information correctly lies with you and you alone.

Determining Maximum Gross Trailer Weight

Your trailer's springs, axles, tires and chassis were all designed to handle a certain maximum load. This load consists of the empty trailer itself, plus the added weight of cargo that you add. This is called the Gross Vehicle Weight Rating or GVWR. In addition, each axle has a maximum weight that it was designed to support. This is called the Gross Axle Weight Rating or GAWR. The total of all axle loads plus the tongue weight should not exceed the GVWR.

CARGO CAPACITY = GVWR – Empty Trailer Weight

Overloading a trailer beyond its rated capacity, even though it may be well balanced and seem to handle fine, is a very dangerous practice. Eventually something is bound to fail with dramatic and unpleasant results. Overloading places excess strain not only on your tow vehicle causing possible failures at the hitch or in your capacity to safely bring it to a stop in an emergency, it also overloads the trailer's frame, axles, bearings and tires.

Be leery of home made trailers. It is amazing how many bad ideas can be incorporated into this group. Do you really want to risk lives, your own included, to save a few bucks on a trailer? How many trailers have you seen fishtailing down the road that were manufactured by a credible company? Probably not many. If you now own an ill-handling, no-name misfit, get rid of it by junking it. It's unethical to sell or use a trailer that could cause a serious accident. Good cargo trailers are usually designed to maintain a proper tongue weight if they are loaded evenly.

It is up to you to find out what the maximum gross weight your trailer should be. Trailers made by reputable manufacturers should contain a tag or instructions which lists loading limits. This can be more of a problem if you have a trailer built twenty years ago by a company that no longer exists and the tag or instructions are missing. If you cannot obtain actual figures from the original manufacturer, take it to a reputable trailer sales or repair facility and get an expert to give his best estimate of its capacity.

Load your trailer well below the maximum for the first tow with a new rig or while you are learning. Keep track of the weights of the individual items as you load them. When in doubt guess high. Using your Sherline™ scale, adjust the load so that you have around 12% to 15% of your best estimated total weight on the hitch. Attach the trailer to the tow vehicle and note how much the rear end drops. (If it looks excessive, check the tow vehicle's load capabilities again.)

Something to think about...

A temporary increase in loading occurs during dips or bumps in the road. A severe dip causes increased weight to suddenly be placed on hitch, axles and tires. Though hitch manufacturers take this into consideration in their designs, an overloaded or old, cracked and rusted hitch or tongue can be suddenly stressed beyond capacity, causing it to fail. Watch for bumps and large dips in the road and try to slow down for them. A conservative safety margin in loading will also be helpful in this type of unforeseen circumstance.

*Know your trailer's
Maximum Gross
Vehicle Weight
Rating (GVWR) and
never exceed it.*

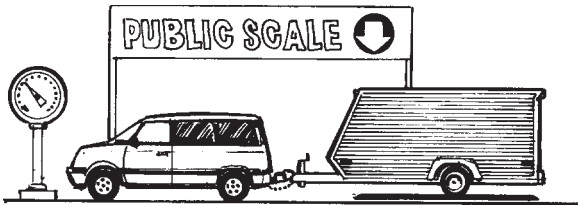

Weighing the Trailer

Though it is not necessary to weigh your trailer every time you load it, it is a good idea in the beginning to have a good cross check to your estimates. Once you have a feel for it, a good estimate is usually close enough unless you are loading

Towing Tip...

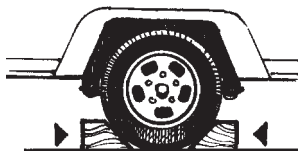

NOTE: Whenever the trailer is detached from the tow vehicle, block the wheels so it is impossible for the trailer to roll off on its own. Better yet, don't ever detach the trailer on any grade.

Accept the fact that towing a trailer is a skill that has to be developed and that you should get all the help you can.

to near your trailer's maximum limits. A 1000 pound error in total weight is only a 150 pound (15%) error in tongue weight.

Weigh the trailer by having just the trailer wheels on the scale. You do not need to disconnect it from the vehicle. Add this weight to the weight at the tongue measured by the Sherline™ scale and you have your gross trailer weight. Knowing the total weight and the tongue weigh allows you to calculate the percentage of weight on the hitch. While you're there the first time, it would be a good idea to also check the vehicle weight at each axle to make sure it is not loaded beyond the manufacturer's specifications. (See the Trailer/Tow Vehicle Load Worksheet on page 21 for details.)

Your Responsibilities as a Driver

What I'm trying to convince you of is that towing a trailer has a responsibility similar to properly driving your car. You wouldn't think of letting your children drive on the road without the proper training, and you shouldn't take a fully loaded trailer that could be improperly loaded onto a busy road to learn with. It is a skill that has to be developed and a responsibility that shouldn't be taken lightly. If you're towing a travel trailer for the first time, you have to start learning with a full load. Drive only when traffic is light and don't drive where traffic conditions might force you into driving faster than you're comfortable with. Get a friend with this type of experience to help you learn. Don't be embarrassed to ask questions or park when it is windy. Learn what it takes to keep from ruining your transmission when pulling heavy loads up a hill or burning your brakes up going down the other side. It is a skill that you can take pride in. The hardest skill to learn is to know when *not* to tow a trailer.

Travel trailers, boat trailers, and specialty trailers are usually designed to have the proper hitch weight, but it would be intelligent to check them. Make sure your hitch is capable of handling the load. You can still screw up the design by putting something heavy where it was never intended to go such as a heavy outboard on the back of a sailboat. Another way of getting in trouble with a boat is towing it when it has a lot of water in the bilges from a rainstorm. If you add heavy items to these type of trailers, put the extra weight over the axles. If you're putting a boat on a trailer for the first time, use the Sherline scale to find the proper place to locate the boat and adjust the trailer to fit the boat.

Driving in Windy Conditions

Wind can create havoc when towing a trailer, causing oscillations or sudden pulling to one side. Thirty mile an hour crosswinds can blow you off the road if there is a sudden gust. For example, say a hard gust of wind hits your rig from the left. Your rig pitches to the right and moves towards right. In order to stay on the road you turn left. With the rig leaning

to the right, the centrifugal force generated by the left turn can be the added ingredient that puts you on your side, or worse yet, down the bottom of a ravine. The only way to help lower the risk traveling in these conditions is to slow down. This eliminates the centrifugal force that happens when you correct, and if the wind did blow you over it wouldn't be such a violent crash. The safest way is not to drive in extremely windy conditions. That's what the professional haulers do, and so should you. Park it until it's safe to continue. Wind can also have a dramatic effect on your fuel mileage when towing a heavy load. Plan your fuel stops accordingly.

Wind and Passing Trucks

An interesting thing happens when being passed by faster moving buses or large trucks. Large vehicles develop a high pressure wave of air in front of them and low pressure area to their rear as they go down the highway. This is variable and is dependent on the shape of the truck and the existing wind conditions. The effect is such that as the truck comes up to pass on your left, first your trailer and then your tow vehicle will be pushed to your right. As the truck passes, the low pressure zone will then pull you back to the left. You must steer first left and then right to counter the effect. It's not particularly dangerous, but it does keep you on your toes.

NOTE: Several types of trailer sway control braces are available that can minimize the effects of wind gusts and passing trucks.



Know about, and be ready for, the effects of wind.

Instructions for Use of the Sherline Scale

How the Sherline Tongue Weight Scale Works

Your Sherline scale uses a hydraulic principle to convert weight into a direct reading on a hydraulic pressure gauge. The reading in pounds per square inch is read as weight in pounds. Any hydraulic pressure gauge that reads in PSI can be substituted for the one supplied should you wish to measure different ranges of weight. Just read the PSI value as pounds.

Recommended Gauge Ranges

For maximum accuracy, select a gauge that puts your final measurement in about the middle of the gauge's range. (For example: for tongue weights of about 1000 lb. use a gauge that reads to 2000 lb.) The reason is that pressure gauges of this type are accurate to within about 2% in the middle ranges, but accuracy decreases to about 3% at extreme low or high readings. To provide a gauge a few percent more accurate would increase the cost by ten times or more. The supplied gauge was chosen as the most cost effective solution to providing a result that is sufficiently accurate for trailer weighing purposes.

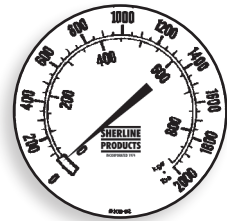

The gauge reads in both pounds on the outer ring and the equivalent reading in kilograms on the inner ring.

NOTE: A rubber plug covers a hole in the gauge body that is used during its assembly. The plug is taped in place during shipping. The plug serves to keep dust and dirt out of the gauge. There are no user serviceable components inside. The tape can be removed once the scale has been unpacked, but the plug should be left in place.

***NOTE:** Gauges with different ranges of measurement are available from Sherline. Contact us for more information should you have a specific requirement that is not fulfilled by the gauge you now own.*

CAUTION: Only atmospheric pressure keeps the cylinder in place. Don't pull up on it, or air could be sucked past the seals into the hydraulic chamber, causing improper measurements.

What to Do if You Get Air in the Cylinder

Loosen the gauge with a wrench. Lay the scale on its side with the gauge at 12 o'clock and unscrew the gauge. Bring the oil level up to the top of the pipe threaded hole by pushing on the piston. (See drawing below for proper piston height.) Keeping the hole level, lightly tap the scale until no air bubbles appear and the fluid is level with the top of the hole. Reinstall the gauge using Teflon tape to seal the threads. Don't overtighten the gauge.

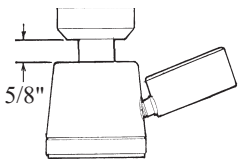

NOTE: If space is less than 1/2", reposition piston and add fluid.

Changing Gauges

Should you wish to use your Sherline™ scale to measure a different range of weights, simply unscrew this gauge and replace it with another gauge which also reads in PSI. It should have a 1/4" pipe thread fitting. Be sure to tip the body of the scale so the hole is up so no hydraulic fluid is lost when the gauge is removed.

When replacing the gauge, push the cylinder down slightly to raise the fluid level right to the top of the hole so that no air enters the system. If fluid is lost, replace with any good quality low viscosity oil, such as hydraulic jack fluid or 20 weight motor oil. Use Teflon tape sparingly on the pipe threads when reinstalling the gauge to prevent leakage.

Detailed instructions for changing the gauge: https://sherline.com/wp-content/uploads/2016/06/lm_replace_inst.pdf

Placement of Your Sherline Scale

The most accurate measurement of tongue weight is achieved by measuring right where the hitch actually rests on the ball. An extension is provided that screws into the top of the cylinder so that you may support the trailer hitch in this manner. Always measure the hitch weight with the trailer level (trailer wheels blocked to prevent movement) and the hitch at the approximate height it will be when installed on the tow vehicle.

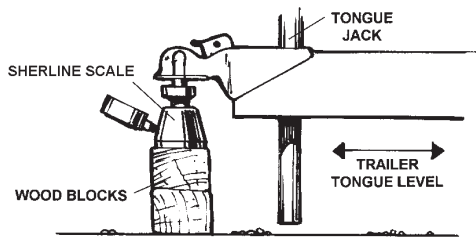

Support the trailer tongue with the tongue jack. Using very strong and secure blocks, block the Sherline scale into position under the hitch. (If you have a hydraulic floor jack, you can make things easier by simply placing the scale on the jack and jacking it into position.) Raise the tongue jack until the full weight of the hitch is on the scale and read the weight in pounds directly from the gauge.

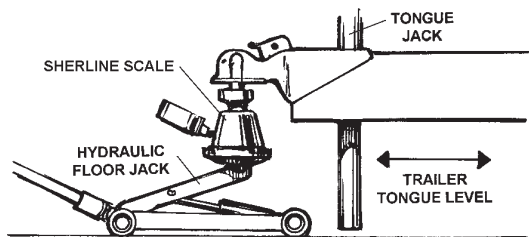

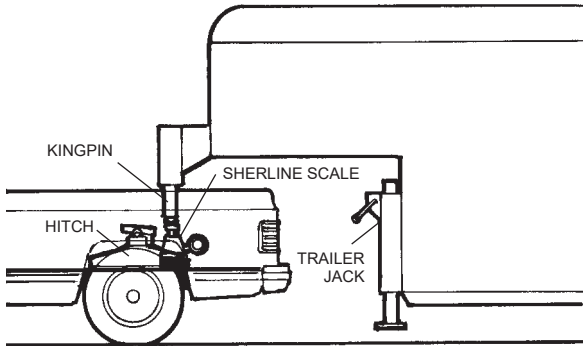

HINT: The gauge on the SHERLINE scale can be rotated 90° to make it easier to read from the side in 5th wheel applications.

For 5th wheel trailers, the Sherline™ scale can be blocked to the proper height directly behind the hitch on the bed of the truck. With the trailer supported by the trailer jack, move the truck forward until the kingpin is directly over the scale. Lower it into position with the trailer jack until the full weight of the trailer is on the scale.

NOTE: Because of the large variety of available 5th wheel hitch designs, some ingenuity may be required on your part to safely support the kingpin on the scale.

Once you are familiar with your trailer, it will be easier to measure tongue weight at the tongue jack rather than at the hitch. Once you have determined the actual tongue weight at the hitch, we recommend you take a reading at the tongue jack itself. With the hitch supported by the tow vehicle but not locked down, place the Sherline scale under the tongue jack. (A depression is provided in the top of the piston to help locate the jack leg or wheel.) Making sure the wheels of the trailer are blocked so it can't roll, crank the tongue jack until the hitch is just free of the ball and all the weight is on the scale. Compare this reading to the one taken at the hitch itself. You will probably find that it is close enough to use as the actual measurement in the future depending on the distance of the jack from the hitch.

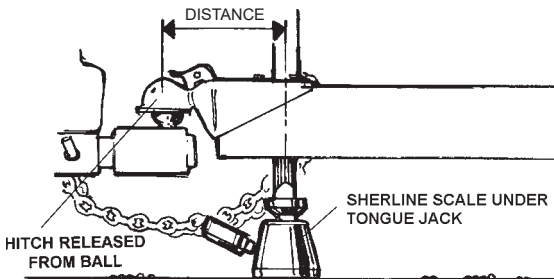

Just keep in mind the approximate ratio and add that factor to your measured figure at the jack.

CAUTION!

The scale must be level when taking a measurement. If the scale is not level or if the trailer exerts a side load on the piston during measurement, the piston shaft can bind in the body and yield an incorrect reading.

Note for Math Pros and Perfectionists:

For the ultimate in accuracy, note the actual difference in weights and calculate the ratio by dividing the full hitch weight by the weight at the tongue jack.

Example:

Wt. at hitch = 950 lb.
 Wt. at jack = 1000 lb.
 $950 \div 1000 = .95$

Future measurements at the jack multiplied by .95 will yield the actual weight at the hitch itself.

Parts Diagram and Description

Sherline Trailer Tongue Weight Scale, P/N LM Exploded View

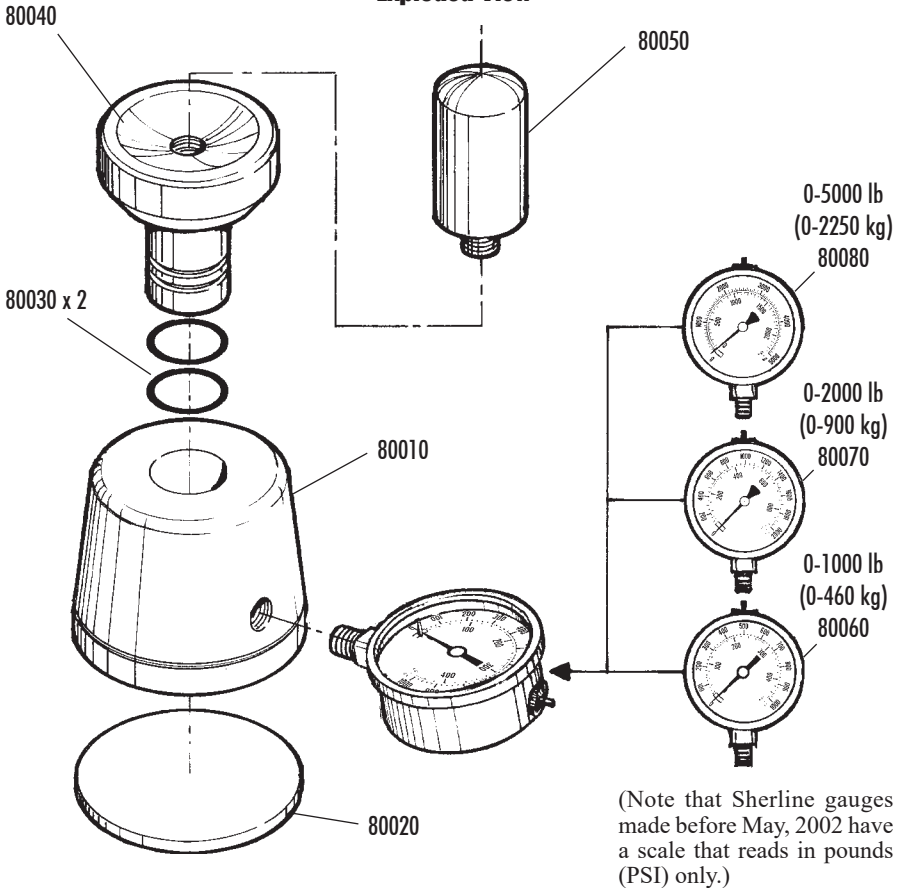

(Note that Sherline gauges made before May, 2002 have a scale that reads in pounds (PSI) only.)

NO. REQ.	PART NO.	DESCRIPTION
1	80010	Body
1	80020	Rubber Base Pad
2	80030	O-Ring Seal
1	80040	Piston
1	80050	Post
	80060	Gauge, 0-1000 lb. (0-450 kg) Capacity
	80070	Gauge, 0-2000 lb. (0-900 kg) Capacity
	80080	Gauge, 0-5000 lb. (0-2250 kg) Capacity

Care and Use of Your Sherline Trailer Weight Scales

1. **Do not lift the scale by grabbing the piston.** Lifting by the piston can cause air to be pulled past the O-ring seal and into the hydraulic chamber. This will cause incorrect or inconsistent readings, just as getting air in a hydraulic brake line will cause braking problems. To bleed air from the scale, the gauge must be removed.*
2. **Do not drop weight suddenly onto or off of the scale.** Lower the trailer onto and off the scale gently. Sudden shock loading can break the needle mechanism or cause it to skip teeth on the fine-toothed gear inside. This can cause the gauge to read outside the zero range with no weight on it.
3. **Do not leave the weight of the trailer resting on the scale** for longer than it takes to take a reading. The O-ring seal is not designed to support continuous pressure. If changing the load of the trailer, do so with the trailer on the hitch or jack and then re-weigh when done adjusting.
4. **Do not “peg” the gauge.** If more weight is put on the scale than the gauge range can handle, and the needle hits the stop peg, the needle can be bent, or the linkage can break. The gauge cannot be repaired.
5. **Make sure the scale is on level ground** and squarely under the load when taking a reading. A side load can cause the piston to bind on the sides of the cylinder, which will result in an underweight reading or readings that are not repeatable.
6. **Pack your scale securely** so it cannot be damaged in transit and handle it carefully. Store it upright. Do not let it bounce around loosely in your trunk, the bed of your truck, or in a toolbox. An impact on the end of the gauge can bend the steel case in relation to the brass fitting. This, in turn, can bend the metal number card inside so the needle hits the card.
7. **We strongly advise that you use a piece of wood** (5/8" thick) and place it between the piston head and body when your scale is not in use. This will help protect the seals from leaking over time.
8. **This scale is a mechanical device.** Just like any other mechanical device, if it sits for a long period of time without use, parts will lock up. For example, if your car is parked in the driveway for six months chances are it's not going to turn over the first time. Therefore, before using it, we recommend that you make the piston turn, and push it down a bit to free its motion to get a more accurate reading. This will help free up the O-ring seal before using. (Do not pull on the piston.)

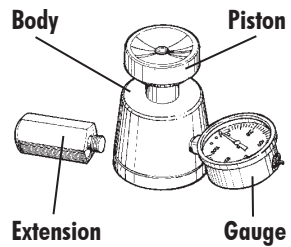

***NOTE:** See page 11 of this booklet for simple instructions on how to bleed air from the system.

For more detailed instructions on how to change the gauge, change the O-ring, and add hydraulic fluid you can view or print out a copy at [lm_replace_inst.pdf](http://lm.replace_inst.pdf) on our website.

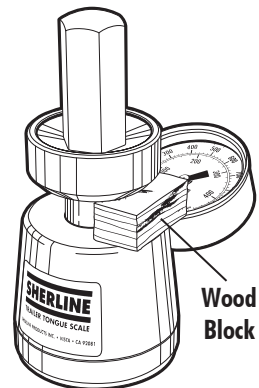

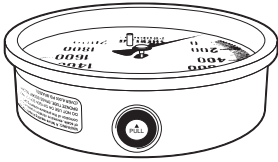

Do **NOT** pull the blue,
dust-cover button

9. Do not store your scale on its side, or in temperatures under 32° F (0°C). Doing so may cause the O-ring seal to fail, causing air to enter into the hydraulic chamber.*
10. Do not pull the blue button. Some scale models may have a blue button on the side of the gauge that says “PULL.” DO NOT pull it. This is simply a dust cover for an access port that is used to fill the scale with glycerin from the factory. You should have no reason to add or remove, any fluid from the scale.

Key Points to Keep in Mind when Using Your Scale

1. **Ideal weight**—Most trailers that are towed using a standard rear hitch are designed to carry 10% to 15% of the total weight of the trailer and its contents resting on the hitch. We consider 12% an ideal figure to shoot for. Fifth-wheel trailers take a larger portion of the weight on the hitch—up to 25%.
2. **Results of improper loading**—Too much tongue weight can damage a trailer tongue, hitch or tow vehicle. Too little tongue weight can result in a dangerous oscillation or “fishtailing” of the trailer.
3. **Measuring at the jack rather than the hitch**—For most trailer loading purposes, the jack is close enough to the hitch that a reading at that point is sufficient. If you prefer more accuracy, measure the weight right at the hitch by using the screw-in extension provided with your scale or use the math formula on page 12 of your Loading and Towing Guide booklet to calculate exactly what the weight on the hitch will be when measured at the jack.
4. **Use of weight distribution hitches**—These are great inventions to make your trailer tow more comfortably and provide better handling and braking for your rig. They do not, however, change the trailer tongue weight. They simply redistribute part of the tongue weight to the rear axle and part to the front axle of your tow vehicle. When taking a reading of the tongue weight, the weight distribution bars or chains should be loose or disconnected.

Share your scale, and this information, with your friends who tow trailers to make the highways safer for us all. Safe Trailing!

NOTE: The Sherline scale is not intended to be used for trade; that is, items priced by weight.

A note about securing your trailer...

A valuable trailer loaded with cargo sitting unattended by the side of the road can be a big temptation for a thief with a trailer hitch. Should you ever have to unhook and leave your trailer in an emergency, consider ways to protect it. The same goes if you store your trailer in an unsecured location. A chain or cable through a wheel and around an axle is a start. There are specially designed locks that fit over the ball socket on the hitch that also make it difficult for a thief to hook up. You might consider keeping one in your tool kit for emergency use.

In Conclusion

We hope that by using your Sherline™ scale, you will have a better knowledge of the factors involved in safely loading and towing your trailer. An actual measurement will give you much greater peace of mind than your best guess. We would also hope you will share your expertise and help friends to better balance their rigs with the fine equipment you now have at hand. Each of us that shares the highway is benefited by having one more safely loaded rig on the road.

Thank you,
Sherline Products, Inc.

Acknowledgments

We would like to thank Fleetwood Enterprises, Inc. of Riverside, California and Wells Cargo, Inc. of Elkhart, Indiana for providing much of the useful information for this manual. We would also like to thank the expert craftsmen at Mel's Welding in Vista, CA for the helpful information they were able to provide about hitches.

Safe Towing Checklist

- Inspect safety chains
- Inspect brake wiring and harness, clean if necessary
- Inspect and/or clean lighting plug and receptacle
- Inspect all hitch components for cracking or broken welds
- Test breakaway switch (lubricate every 3 months)
- Check tire pressures, inspect each for wear
- Check wheel nut torque
- Check exterior lighting, brake lights and blinkers
- Lubricate coupler and latch

Check each time before you tow

Trailer/Tow Vehicle Load Worksheet

Note the following information from vehicle placards and/or manufacturers' specifications:

Tow Vehicle
MFGR: _____
MODEL: _____
GVWR: _____
GAWR, Front: _____
GAWR, Rear: _____

Tow Vehicle Hitch
MFGR: _____
MODEL: _____
CAPACITY: _____
MAX. TONGUE WT. CAP. (10% of total capacity):

Trailer
MFGR: _____
SERIAL #: _____
GVWR: _____
GAWR (ea.): _____
MAX. TONGUE WEIGHT: _____

Scale Readings

Take weight measurements with both tow vehicle and trailer fully loaded with driver, passengers, cargo and fuel. If using a weight distribution type hitch, have spring bars tightened.

- TOW VEHICLE FRONT AXLE: _____ lb. Confirm that each measurement does not exceed manufacturer's specifications listed above.
- TOW VEHICLE REAR AXLE: _____ lb.
- TRAILER ONLY: _____ lb. (Disconnected from tow vehicle.)*
- TRAILER WT. ON AXLES: _____ lb. (Connected to tow vehicle.)
- TRAILER WT. PER AXLE: _____ lb. (Divide trailer weight by # of axles.)

Sherline™ Scale Readings

Take weight measurements with trailer fully loaded with cargo. Consult instructions for proper way to measure tongue weight.

- TRAILER TONGUE WEIGHT: _____ lb. Confirm that measurement does not exceed manufacturer's specifications listed above.

Calculating Tongue Weight Percentage

1. TONGUE WEIGHT (Sherline scale reading): _____ lb.
2. TRAILER ONLY WEIGHT (Scale reading*): _____ lb.
- (Line 1 ÷ Line 2) x 100 = % OF WEIGHT ON HITCH: _____ %

***Note:** if the trailer weight is taken with the hitch still connected to the vehicle, add the Sherline tongue weight to the scale weight to get the total trailer weight.

EXAMPLE:

$$\begin{aligned} \text{Tongue Weight} &= 750 \text{ lb.} \\ \text{Trailer Weight} &= 5550 \text{ lb} \\ 750 \div 5550 &= .1351 \times 100 = \mathbf{13.51\%} \end{aligned}$$

In the above example, the tongue weight percentage is within the safe recommended range of from 10% to 15% of the trailer weight resting on the tongue. If your calculated percentage falls outside the safe range, rearrange the cargo, remeasure and recalculate until you achieve a safe figure.

Warranty

Sherline™ scales are warranted by Sherline Products, Inc. for one year from time of purchase to be free of defects in manufacturing and assembly. This includes all parts, seals and the gauge installed at purchase. Should any problems occur with the proper functioning of the scale, return it to the address below along with dated proof of purchase for repair or replacement at our option. This warranty does not cover damage due to misuse, neglect, overloading or improper installation of a gauge other than the one installed by the factory.

Gauge accuracy is warranted by the gauge manufacturer to be within 2% at mid range of the gauge. (Accuracy diminishes to 3% at either extreme of the gauge's range.) These gauges are not recommended for trade purposes.

In addition to trailer weight scales, Sherline Products Inc. manufactures a complete line of miniature machine tools and accessories as well as a line of quick-change 3- and 4-jaw chucks for full size machine tools. Call or write for more information on other fine Sherline Products or see our website at:

www.sherline.com

SHERLINE
PRODUCTS

INCORPORATED 1974

Sherline Products Inc. • 3235 Executive Ridge • Vista • CA 92081-8527
Toll Free Order Line: 800-541-0735
Local, International or Technical Assistance: 760-727-5857 • Fax: 760-727-7857
Email: sherline@sherline.com