



Ball Leadscrew Customer Notice

Receiving Your New Ball Leadscrew Retrofit Kit

1. Our ball leadscrews are inspected, checked, and adjusted at the factory.

We DO NOT accept the return of ball leadscrews from retrofit kits for any reason.

2. There are O-rings on your ball leadscrews to help to ensure that your ball nut does not come off your leadscrew. ***These O-rings must remain on your leadscrew until your assembly is complete!*** Once your assembly is complete, cut the O-rings off before you attempt to use your machine.

Keeping Your Y-Axis Leadscrew Chip Free

3. Your machine must have a brass Y-axis tube cover, and Y-axis accordion covers on it to prevent chips from getting on your ball leadscrew.
5. **DO NOT** use pressurized air to blow chips off your machine. Use a small brush or rag to wipe the chips off. The use of pressurized air will eventually force chips onto the ball leadscrew, and this will, in turn, damage the ball nut.
6. Brush chips off the top of the Y-axis accordion cover while you are machining, to avoid excessive chip buildup on the covers. Excessive chips on the Y-axis cover will eventually restrict the movement of the Y-axis and cause the stepper motor to stall and miss steps.

Lubrication

7. **Dovetail surfaces:** Use “3-in-1” oil or a light sewing machine oil to lubricate your dovetail surfaces. Fill the oiler cup on the mill saddle. Use your finger to apply oil to the bed dovetail and the mill table dovetail.
8. **Ball screws:** The ball screw manufacturer recommends NSK Grease AS2 for lubricating the ball leadscrews. Move the axis to the end of travel and put a minimal amount of grease on your fingertip. Apply it along the length of the leadscrew from the ball nut to the stepper motor mount.

Retrofits

NOTES: Read ALL of these notes.

1. The charge for all ball leadscrews is the same, regardless of the overall length. This is because the manufacturer does not give us a price break on the shorter screws (in fact, they wanted more for a 6" ball screw). All screws come in at 400mm (15.75mm) long, and we cut them to length to fit the individual machine axis.
2. All retrofits come with the stepper motor mount, high-torque coupling, bearings, preload nut, and ball screw fully assembled in our factory. We do not sell these parts individually for you to assemble.
3. The ball leadscrew and the rest of the assembly are assembled and checked in our factory. We place an O-ring on the end of the ball screw, below the saddle, away from the motor mount. The O-ring is placed there to help ensure that the ball nut does not thread itself off the ball screw. If the ball nut threads off the ball screw, the balls in the ball nut will come out. At this point, the ball screw is scrap. There is no way to fix it! For this reason, the O-ring is to remain on the ball screw until the ball screw assembly is fully assembled on your machine. After you have fully assembled your ball screw on your machine, you may remove the O-ring.

NOTE: On retrofits, the only way possible for your ball leadscrew to have excessive slop (backlash), is if some of the balls have come out of the ball nut. We will not replace ball leadscrews that have excessive slop (backlash)!

4. On 2000 mills and NexGen mills, the column bed must be assembled to the arm mount as shown in the pictures below. If it is assembled 180 degrees off from the position shown, the bed will sit lower and the end of the ball leadscrew will interfere with the arm mount.

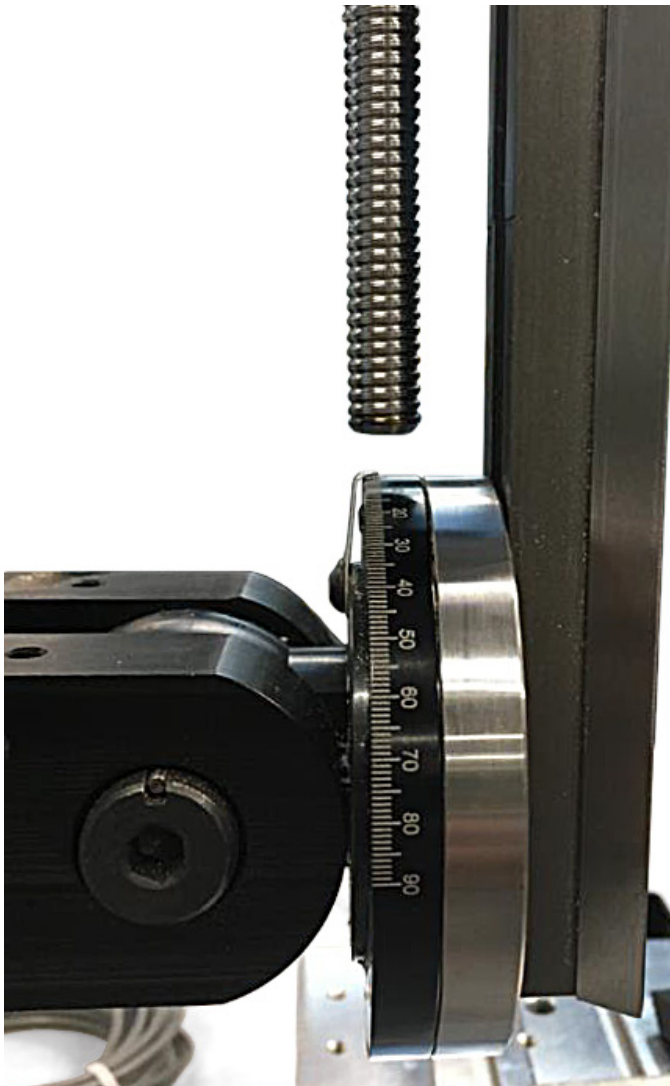

Picture of a 2000 or NexGen Column

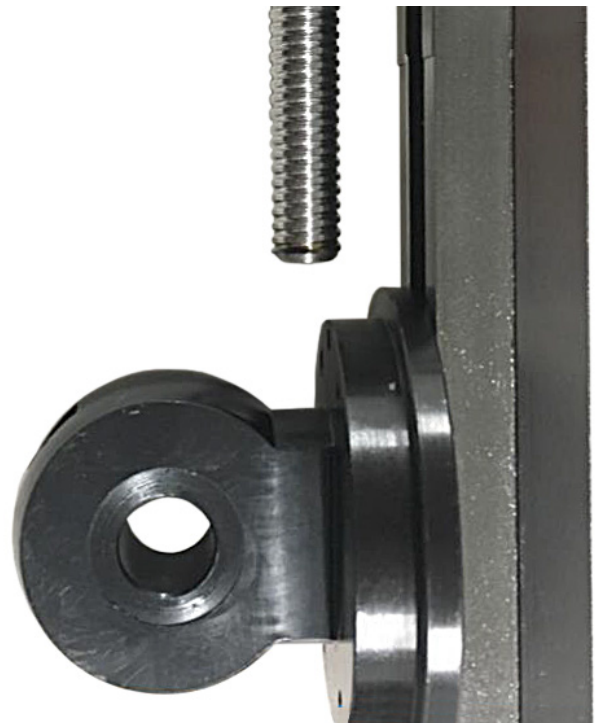

Picture of a column with the 56442 Arm Mount

1. P/N 6800 Mill Z-Axis Retrofit

If you have a CNC mill, the two 8-32 holes are already drilled and tapped in the top end of your column bed. We use the same two holes to mount the new ball screw mount.

If you are converting a manual mill, you will need to buy P/N 67116 to drill and tap the two 8-32 holes.

Video Instructions: Retrofitting a Sherline Mill with a Z-Axis Ball Screw Column—<https://youtu.be/N5xMEcazi2k>

Parts List:

Key upgrade parts are the Ball Leadscrews, ball screw stepper motor high-torque coupling, vertical milling column saddle for ball screws, and column saddle Z-axis ball nut mount.

SPECIAL NOTE: The new column saddle on the Z-axis is longer and the headstock mounts towards the bottom of the saddle. We did this because the 45046 “column saddle Z-axis ball nut mount” would not allow the original saddle to move low enough to the top of the mill table. Additionally, the P/N 45046 reduces the overall amount of Z-axis travel. For this reason, we suggest that you upgrade to the P/N 45265 the (15" Column Bed with electroless nickel with Teflon plating). This bed makes up for the loss of travel in the Z-axis, and it also adds increased lubricity and rust prevention due to the nickel and Teflon plating.

P/N	Description
45165/11", 45295/ 15"	Ball Nut Leadscrew 10 x 2mm, Z-Axis (cut to length)
67101	Stepper Motor Mount (with 3 mounting holes)
671052	CNC High-torque coupling (ball screw)
67120	Stepper Motor Preload Bearings
67115	5-40 x 7/8" SKT HD Cap Screw
67111	8-32 X 7/8" SHCS
67104	CNC RH Coupling Preload nut (course)
45045	Vertical Milling Column Saddle for Ball Leadscrews
45046	Column Saddle Z-Axis Ball Nut Mount
40990	Column Gib (Full Length with ends cut off)
40900	82 degree x 3/8" Flat Head Screw
45035	Motor Mount to Bed Adapter for Ball Screws
58508	X/Y & Z Ball Nut Mount
40730	10-32 x 2" SHCS
40740	10-32 x 7/8" SHCS
40330	10-32 x 5/8" SHCS
40690	10-32 x 3/4" SHCS
40660	#10 Washer
58512	Ball Screw Template Y-Axis
58513	Ball Screw Template X-Axis
12050	8-32 X 3/8" SHCS
40570	3/32 Hex Key
68459	Z-Axis 2-1/2" Adjustable Handwheel (2mm laser engraved lines)
Optional additional upgrade parts are:	
56442	"Arm Mount" for Ball Screw
67126	Stepper Motors 2-Amp High Torque
45265	15" Column Bed (Electroless Nickel/Teflon Plated)

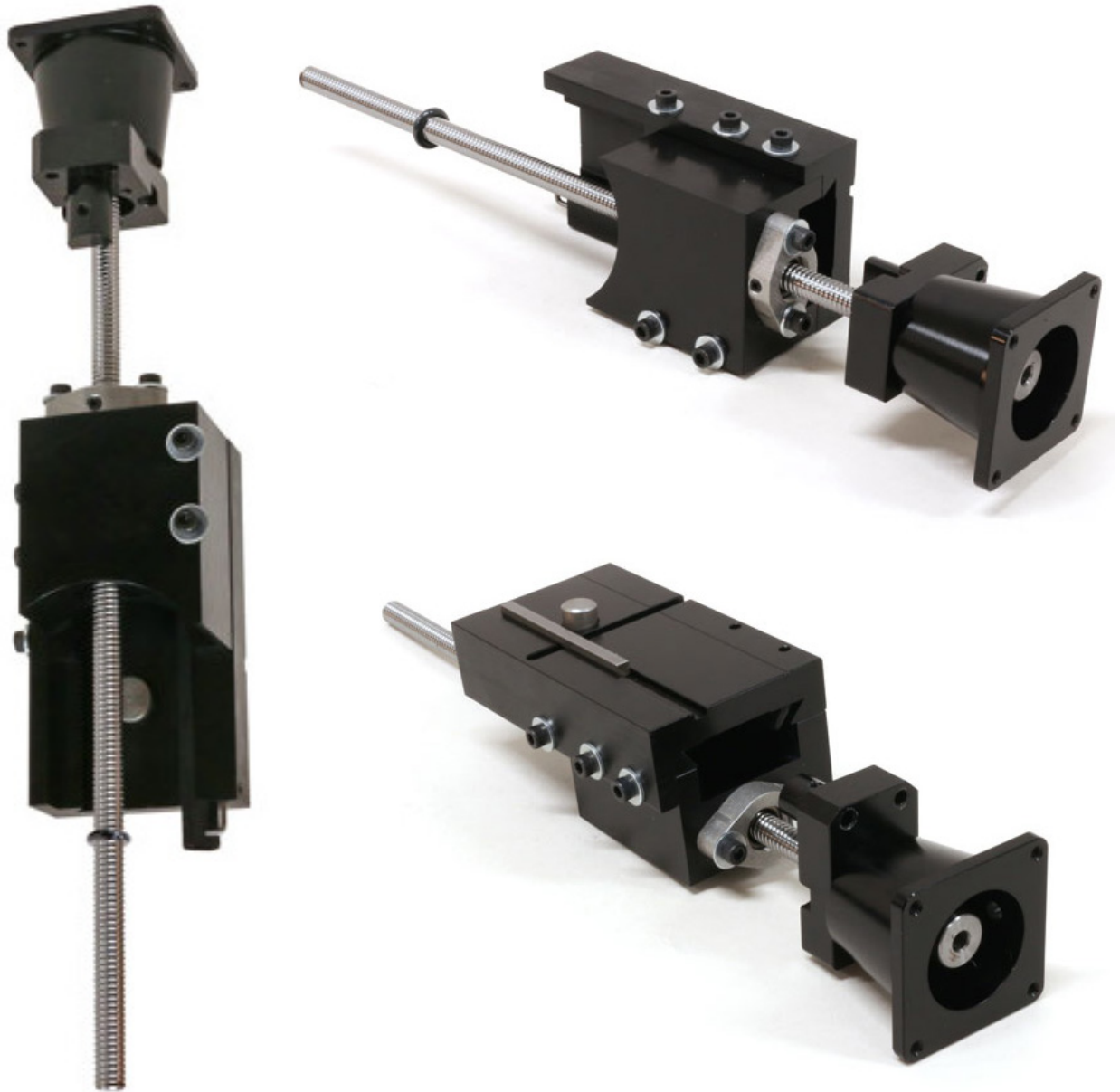

Pictures of Z-axis retrofit

2. P/N 6810 Mill X/Y-Axis Retrofit

Machine modifications:

1. You must drill and tap additional 10-32 holes in your mill base and your mill table in order to mount the X and Y-axis motor mount adapters (P/N's 58510 and 58511) for the ball screw. We include P/N's 58512 and 58513 ball screw templates Y- and X-axis. These are mounted to your machine so you can drill #21 holes accurately. Once the holes are drilled, you can hand tap them with a 10-32 tap. The thread depth should be ½" deep. .

Video Instructions: Retrofitting a Sherline Mill with an X/Y-Axis Ball Screw Assembly—<https://youtu.be/6y7XtNPgGJw>

2. For all mill retrofits, you must drill a ½" hole through your column base. This is a clearance hole for the brass cover tube (P/N 59165) to go through the column base. Following on the next page, are copies of the prints for both the standard column base and the rigid and 2000 column bases.

If you would like us to do the machining for #1 or #2 noted above, the cost will be \$60.00 for each, plus shipping.

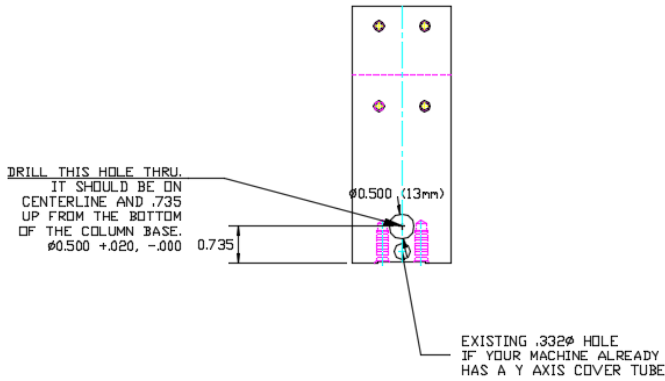

Print for 1/2" hole in a standard column base

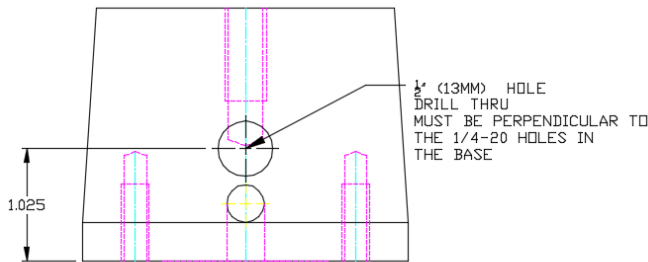

Print for 1/2" hole in a 2000 column base

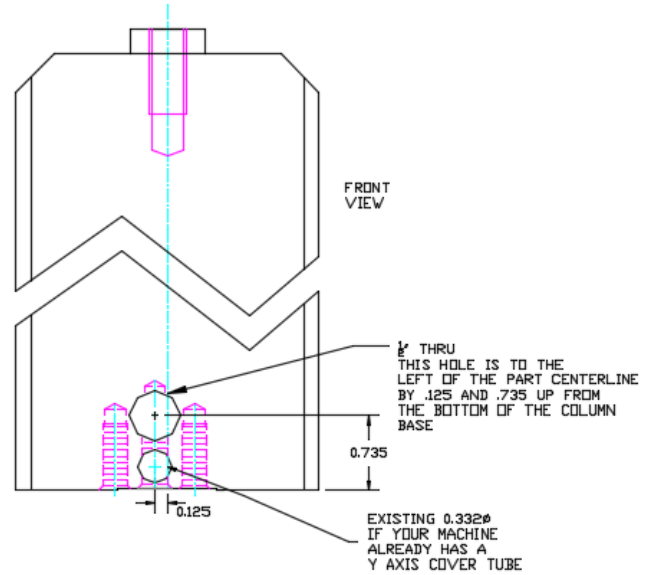

Print for 1/2" hole in a rigid column base

Parts List:

Key upgrade parts are the Ball Leadscrews, ball screw stepper motor high-torque coupling, and the ball screw mill saddle (with nickel / Teflon plate).

P/N	Description
5855	Mill Accordion Way Cover Set for Ball Screw Mill Saddle NOTE: Your machine MUST have one of these on the front side of the mill saddle to keep chips off of the ball screw! The Y-axis brass cover tube P/N 59165 will protect the back side of the ball screw. If you decide that you don't want a cover on the back side, that is your option. However, there must be one on the front side.
	Ball Nut Leadscrew 10 x 2mm, X and Y-Axis (cut to length for mill table and mill base)
54175/13", 54185/18"	Mill Table Ball Screw
54162/12", 56162/14", 56195/18"	Mill Base Ball Screw
67101	Stepper Motor Mount (with 3 mounting holes)
671052	CNC High-torque coupling (ball screw)
67120	Stepper Motor Preload Bearings
67115	5-40 x 7/8" SKT HD Cap Screw
67111	8-32 X 7/8" SHCS
67104	CNC RH Coupling Preload nut (course)
58910	Mill Saddle W/oiler and (Electroless Nickel W/Teflon plated)
50930	Mill Saddle "Oiler Cap"
50920	Mill Saddle Oiler Body
58510	Y-Axis Motor Mount Adapter
58511	X-Axis Motor Mount Adapter
58508	X/Y & Z Ball Nut Mount
40980	Gib
40820	Gib Lock

59165	Y-Axis Brass Cover Tube #8137 7/16" x .014 wall x 13.50" long (Cost \$2.00 ea.)
40690	10-32 x 3/4" SHCS
40660	#10 Washer
40740	10-32 x 7/8" SHCS
58512	Ball Screw Template Y-Axis
58513	Ball Screw Template X-Axis
68429	X-Axis 2" Adjustable Handwheel (2mm laser engraved lines)
68430	Y-Axis 2" Adjustable Handwheel (2mm laser engraved lines)
Optional additional upgrade parts are:	
67126	Stepper Motors 2-Amp High Torque

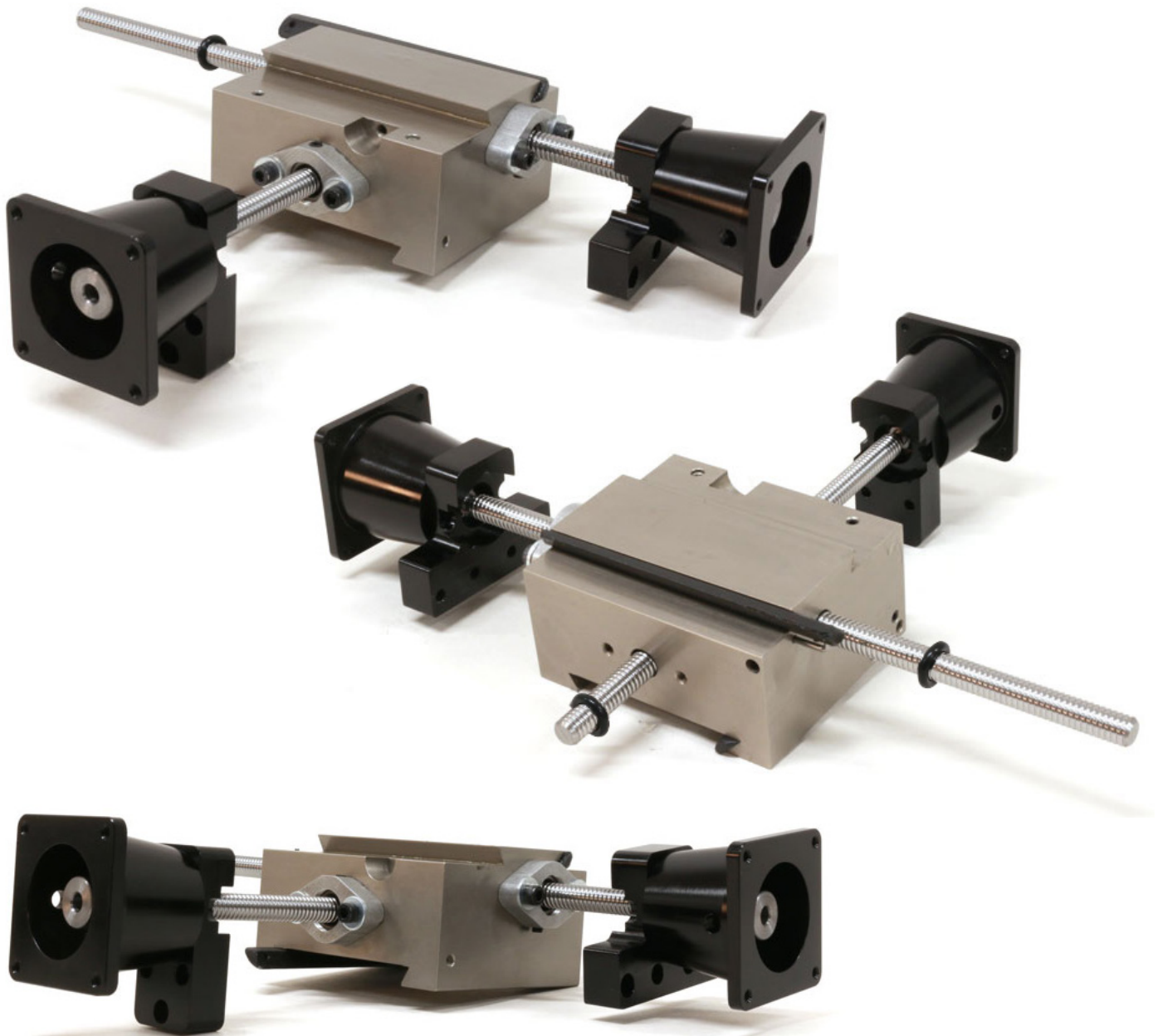

Pictures of the X/Y Retrofit